

Jobon

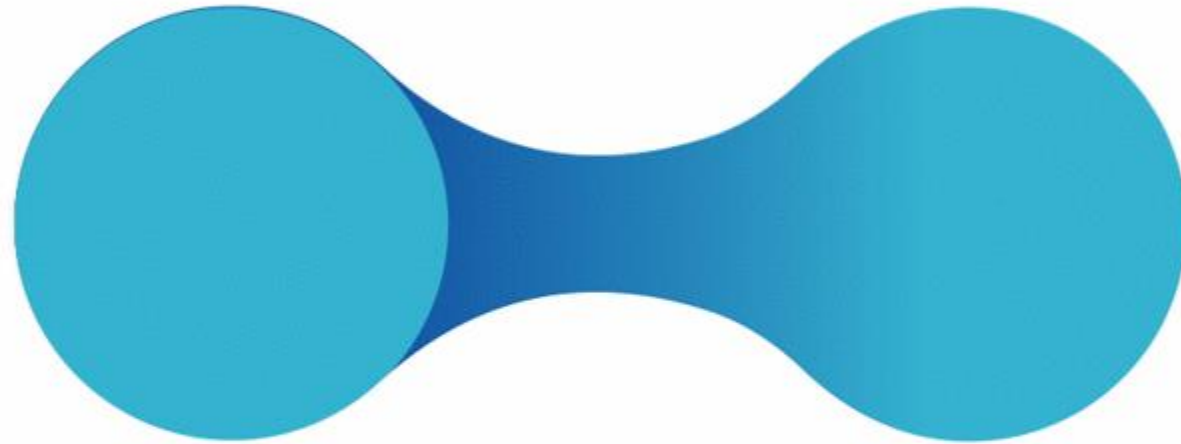

Marine&Navy Application

公司简介



苏州聚邦机械科技有限公司位于国内著名的园林城市，世界500强企业云集的苏州市工业园区。本公司专注于船舶，汽车，铁路，g电力和医疗等领域的橡胶制品及高性能塑料制品的研发、生产、销售及工程施工。

主要的产品系列有：减震/振器，缓冲支撑，橡胶及金属膨胀接，密封圈，耐磨环，弹簧减振台；恒力吊，管道夹；高性能塑料板材，棒材；玻璃钢格栅等复合材料及制品。目前，我们和国际著名的公司有代理及合作关系，如特瑞堡，哈金森，昂斯菲特，德尼凯，Fibergrate，劳士领，LISEGA，VIRBTECH，L&L等。

聚邦的核心团队由十多年高分子行业经验的专业人士组成。成立以来，本着专业，专注，精益求精、推陈出新的经营理念，致力于高品质橡胶制品，高品质阻力弹簧，PTFE，PEEK等高性能材料和高技术含量产品的引进和贸易。在船舶，电力（水电，核电），石油化工，铁路机械，医疗，钢铁，造纸，建筑等领域收到广泛认可。

我们的愿景是让您的设备远离震动伤害、摩擦损耗、噪音侵扰和油品泄露，油污腐蚀，使设备运行更加稳定和舒适。

在售后服务上，企业以“诚信、优质、满意”为服务目标，已形成了覆盖全国范围的售后服务网络，以满足顾客的需求！

1.

橡胶制品：
减震器，
膨胀节，
密封圈，
皮带，轮胎

2.

玻璃钢制品：
格栅

3.

高性能塑料：
PEEK,
PAEK,PPSU

4.

金属制品：
全金属减震，
AV减震台，
阻尼器

5.

品牌代理
PAULSTRA
VIBRACHOC
STOP-CHOC
BARRY
CONTROYS

1. 橡胶：膨胀节，胶管，密封件，减振器, 阻尼器

2. 高性能塑料：PEEK, PAEK

3. 玻璃钢：格栅

4. 弹簧：弹簧减震台，TMD，管道吊架

公司愿景：让您的设备远离震动伤害、摩擦损耗、噪音侵扰和油品泄露，运行更加稳定和舒适。

我们的优势：集成方案的提供者

合作品牌

jobon



船用-胶管/疏浚管/漂浮管/膨胀节

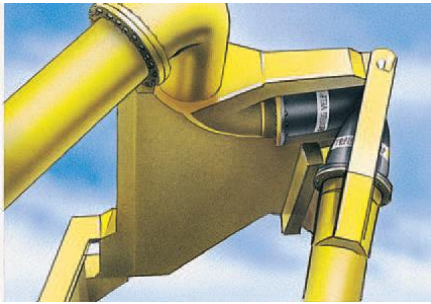
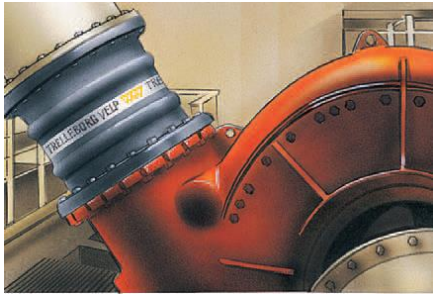
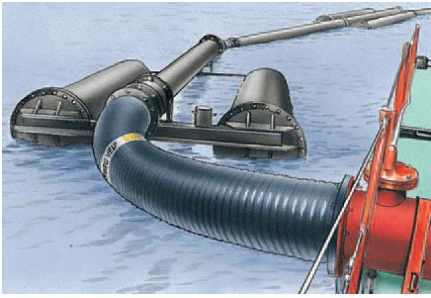
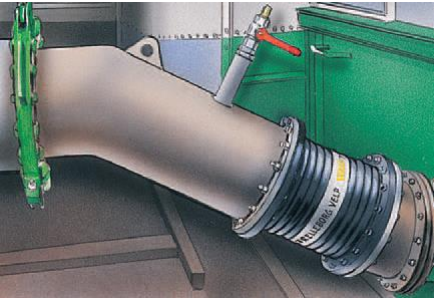
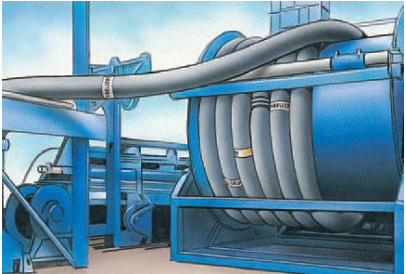
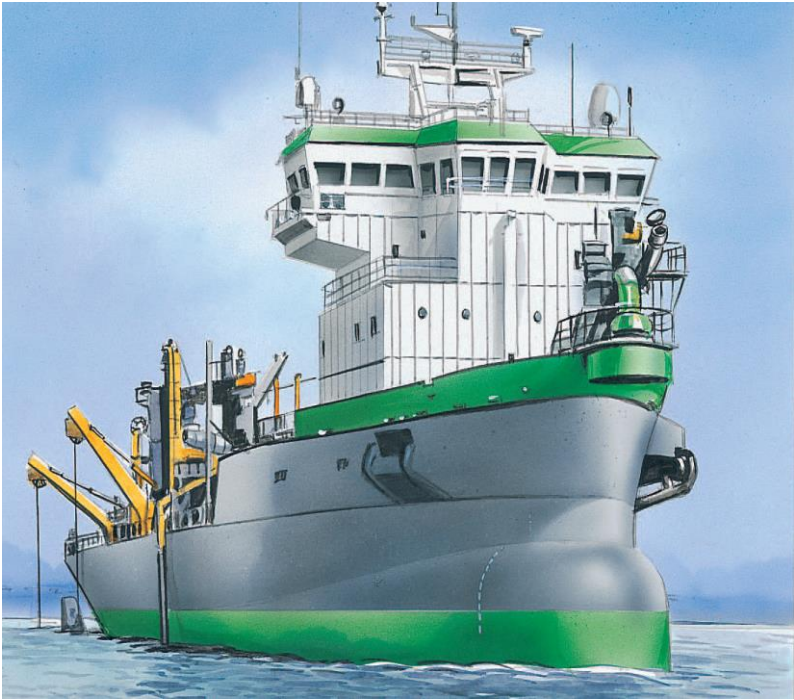

船用-胶管/疏浚管/漂浮管/膨胀节

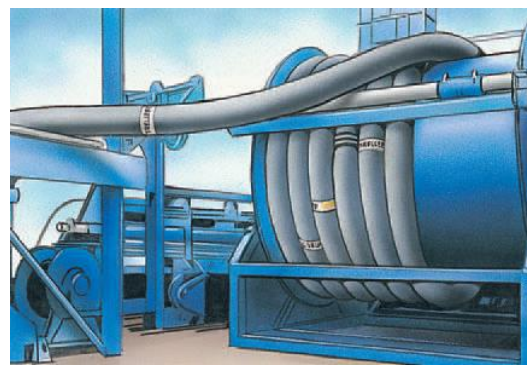

船用-胶管/疏浚管/漂浮管/膨胀节



船用-胶管/疏浚管/漂浮管/膨胀节/弯头

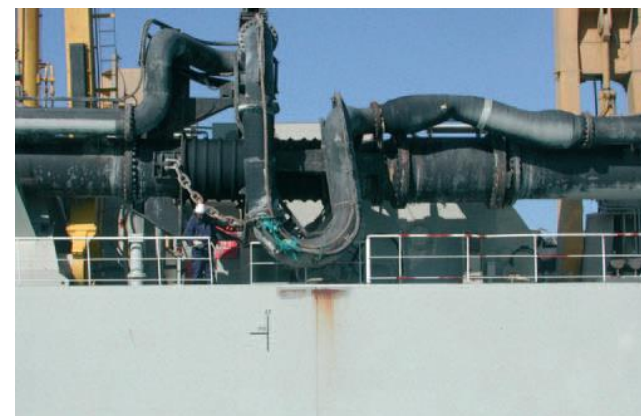

膨胀节 / Expansion Joint

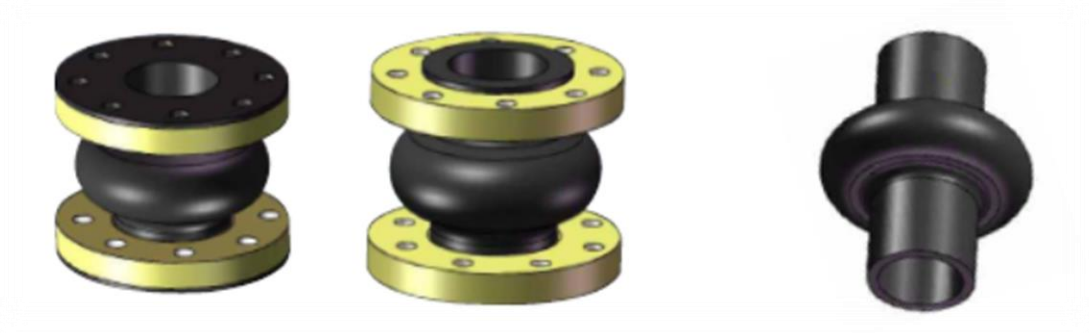



Extrusion Fender
挤出护舷

Cylindrical Fender
圆筒护舷

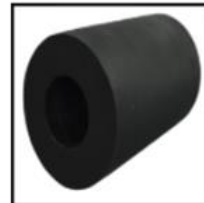

Composite Fender
复合型护舷

Pneumatic Fender
充气护舷



Application应用





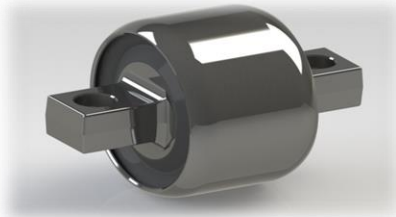

全金属减震器-船舶行业应用

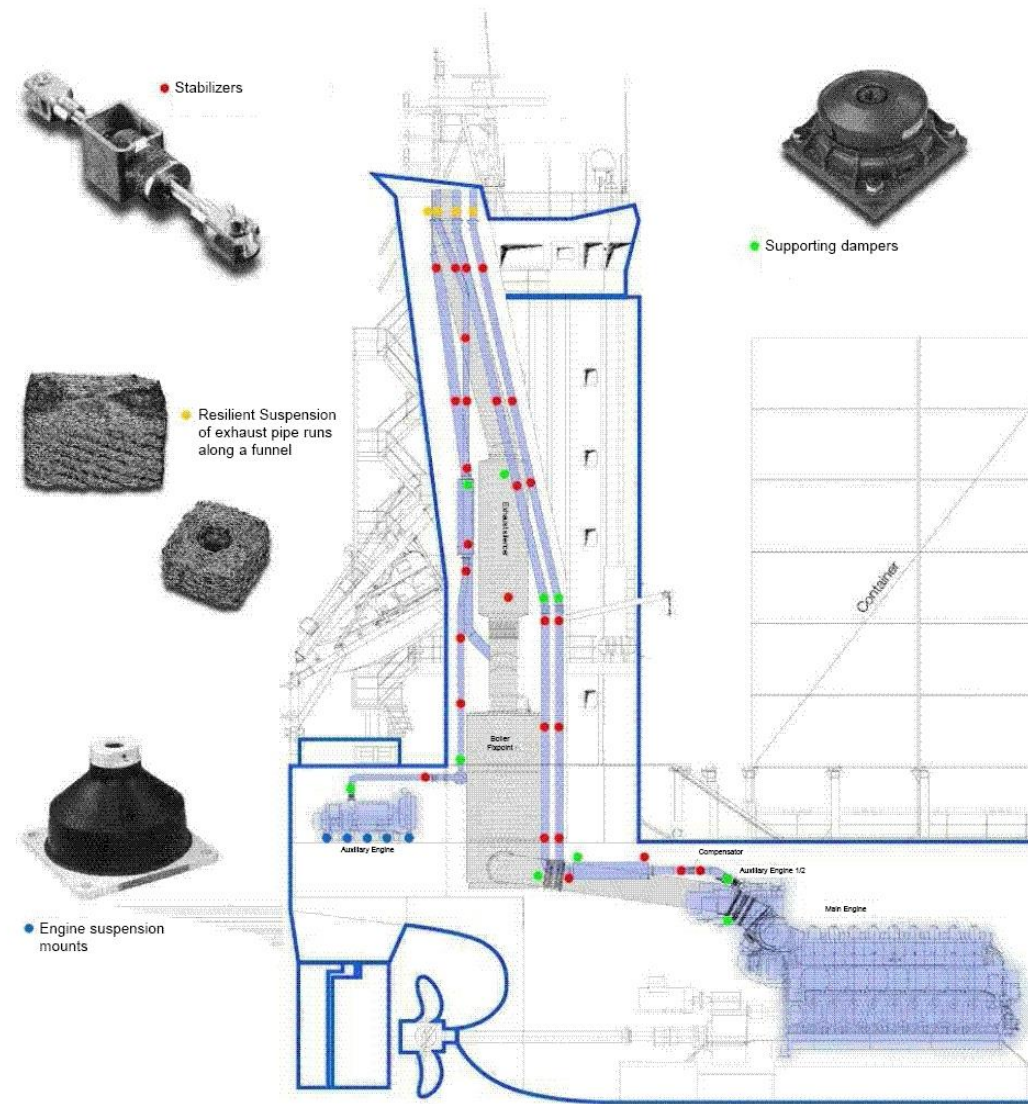

全金属减震器-船舶行业应用

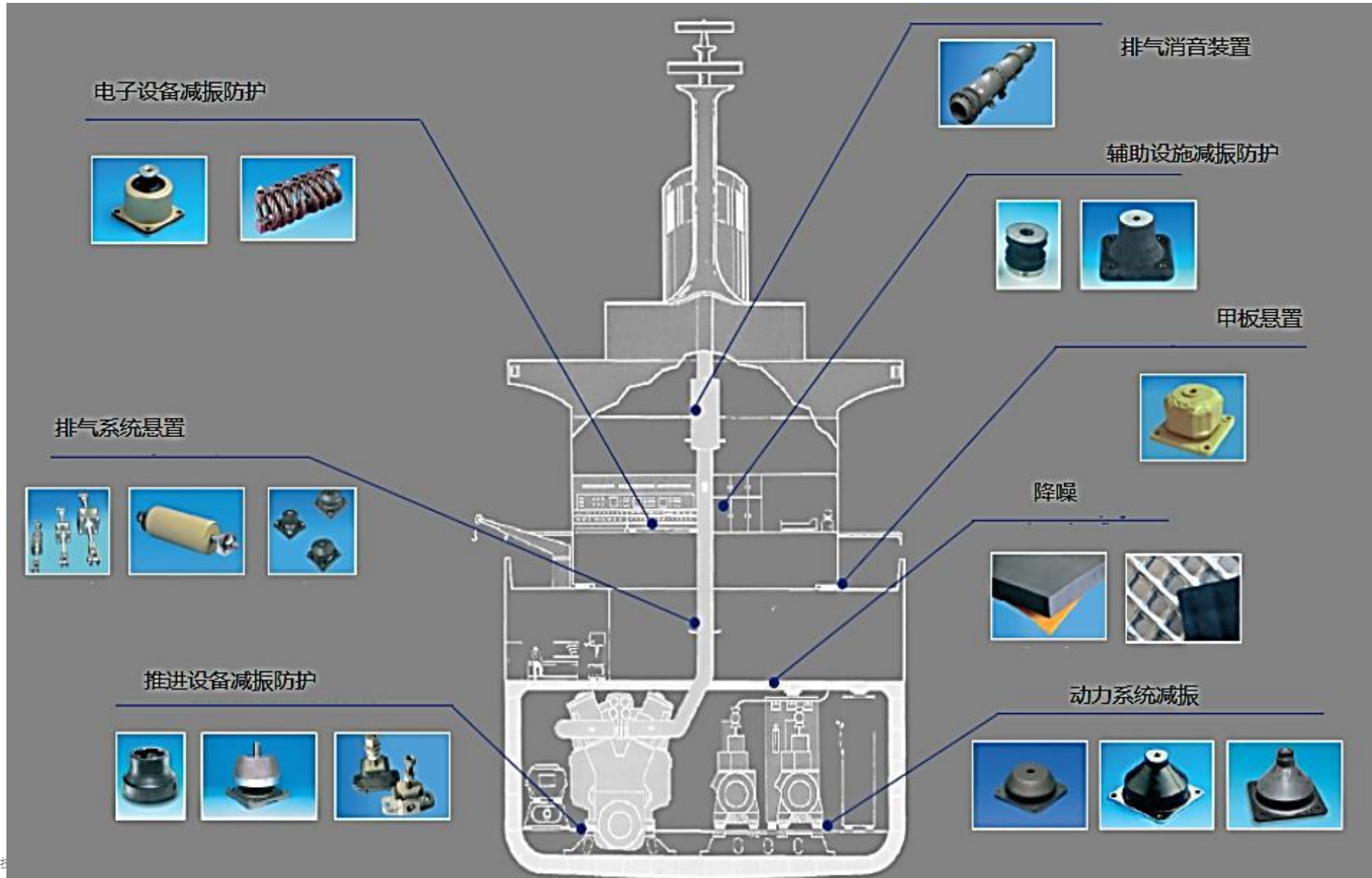

悬置产品及其应用

- 1
- 2
- 3
- 4
- 5
- 6
- 7



固定管子产品（金属丝）

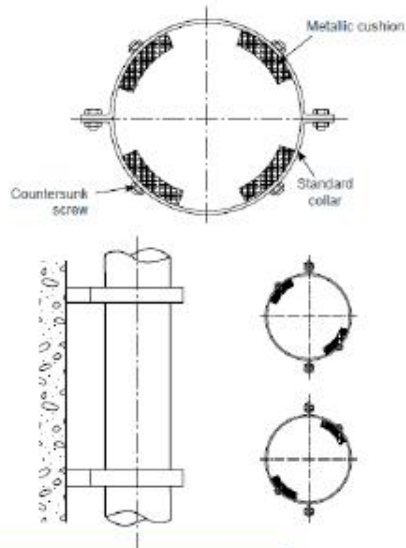

- 管子直径从10-150 mm
- 温度范围: 0-175° C
- 最大变形量: 5mm
- 刚度值低

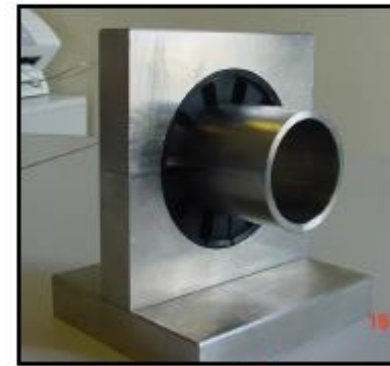

- 管子直径 10.2-6000mm
- 温度范围: -70° C to 300° C

SP减振器及其应用

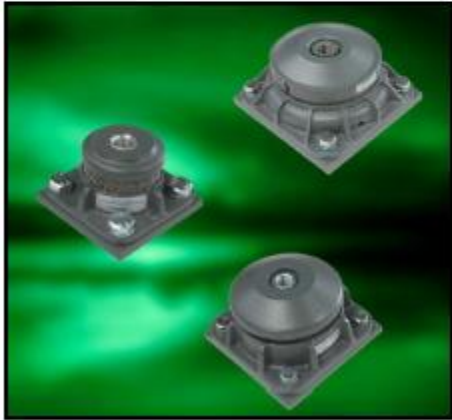
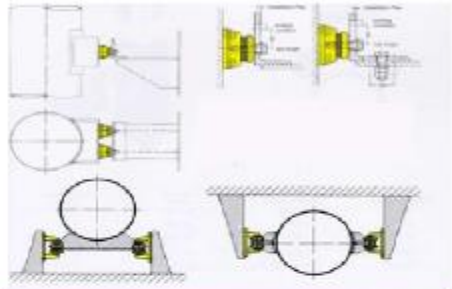

SP减振器及其应用



推进系统减振防护产品

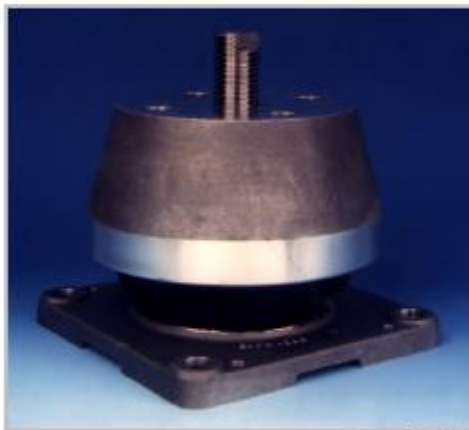

舱壁悬挂

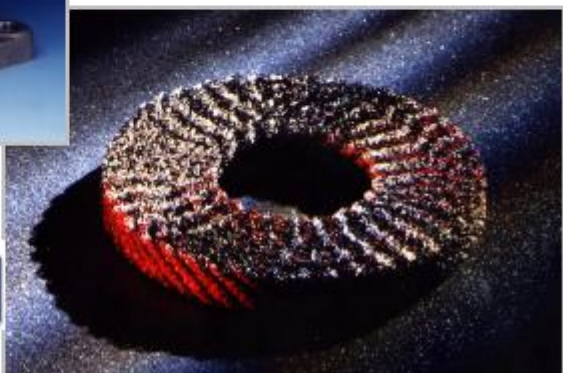

动力系统减振



动力系统减振器



船用联轴器

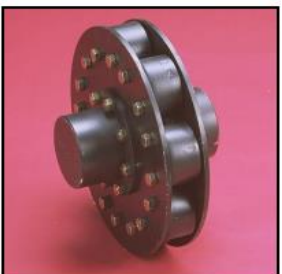

SNA-NG (Barracuda)
扭力 800 KN*m, 角度10 deg
偏移 (3 directions) +/- 50 mm

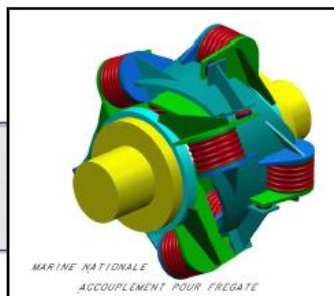

电子设备减振



电子设备防护减振器



主动隔振技术

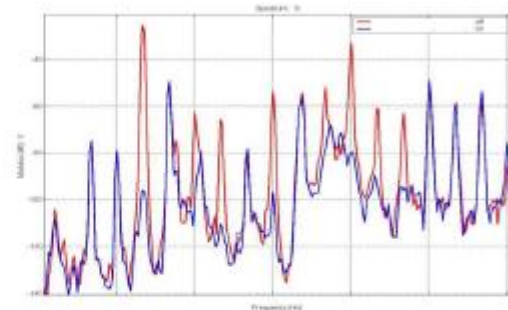
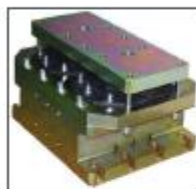

工作原理：由感应器将信号传递到控制器，并由激励器作信号补偿，从而达到消除不需要的振动和噪音的效果

案例：MTU发动机上加主动隔振后，噪音降低了30dB



天花板减振

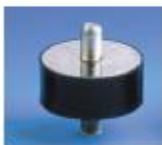

吊挂产品取代了传统的双头螺杆产品

降噪吸音棉



材料特点：
耐火、绝热
自粘背胶，易于安装
在125-5000HZ范围内，吸收20%-85%的噪音
工作温度：-40-150 °C



海工船



全金属减震器



Applications in the
exhaust gas area

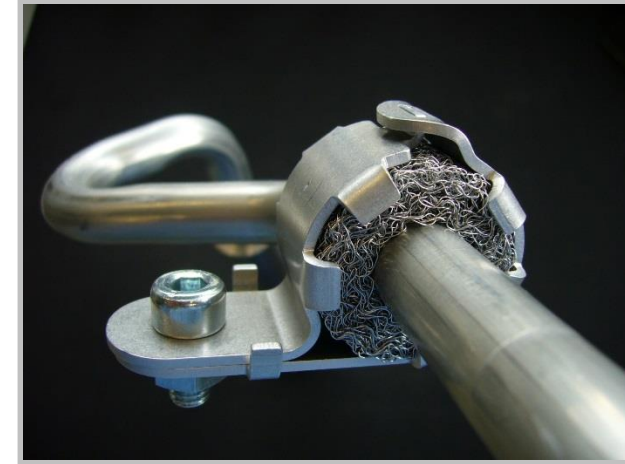



Fluid Sealing Systems



Static Seals



Bearings and Bushings



Rotary Seals



Pneumatic Seals



O-Rings



Engineered Molded Parts



**Mechanical Face Seals
(Heavy Duty Seals)**



**Brake Shims,
Tuned Absorbers,
Rubore® Seals**



Assembly Units



**Liquid Silicone
Rubber (LSR)**



**Customized
Aerospace Sealing**



皮帶



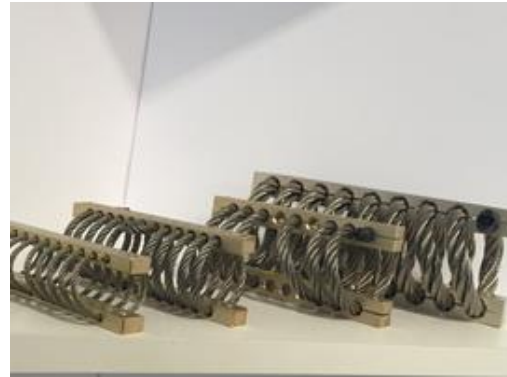

组合式全金属多向防振安装件

不老化
耐腐蚀
高内在阻尼
低共振放大
强冲击衰减
宽温度范围（-180°C至+300°C）免维护

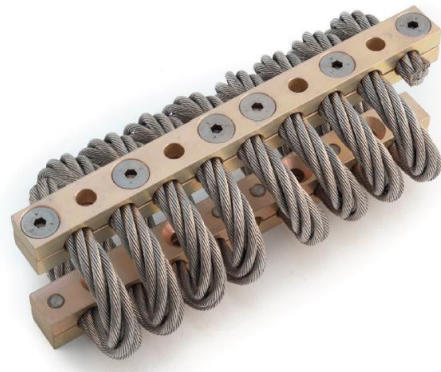

Rolls-Royce Kamewa AB

典型应用：

- ▶ 满足军用标准的弹性悬挂件
- ▶ 隔离敏感性电装
- ▶ 隔离发电机、泵和压缩机
- ▶ 排气系统悬挂件
- ▶ 隔离柜、容器等
- ▶ 在设备运输过程中起保护作用
- ▶ 极端温度应用



Kongsberg Defence & Aerospace AS

阻尼器，恒力吊，管道支撑

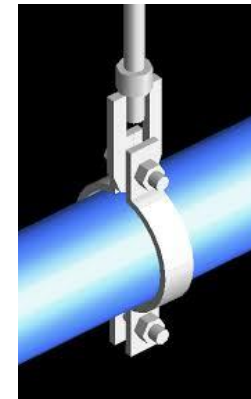
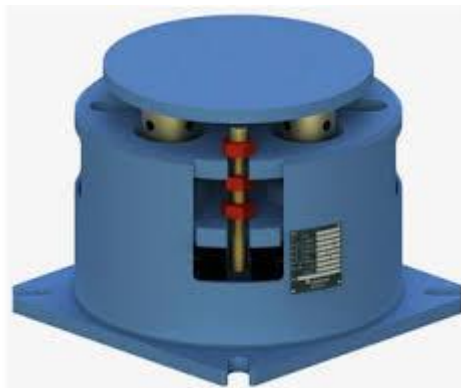
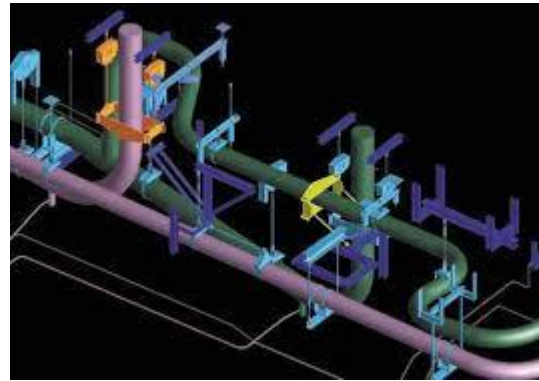

玻璃钢格栅-Fiberglass



**Integrally
Applied Grit**

玻璃



**Meniscus
Top**



**Aqua Fine
Grit**

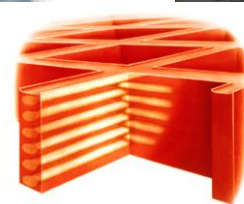
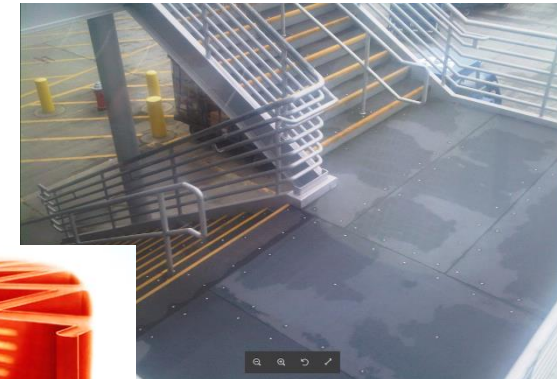



Glenmore Platforms



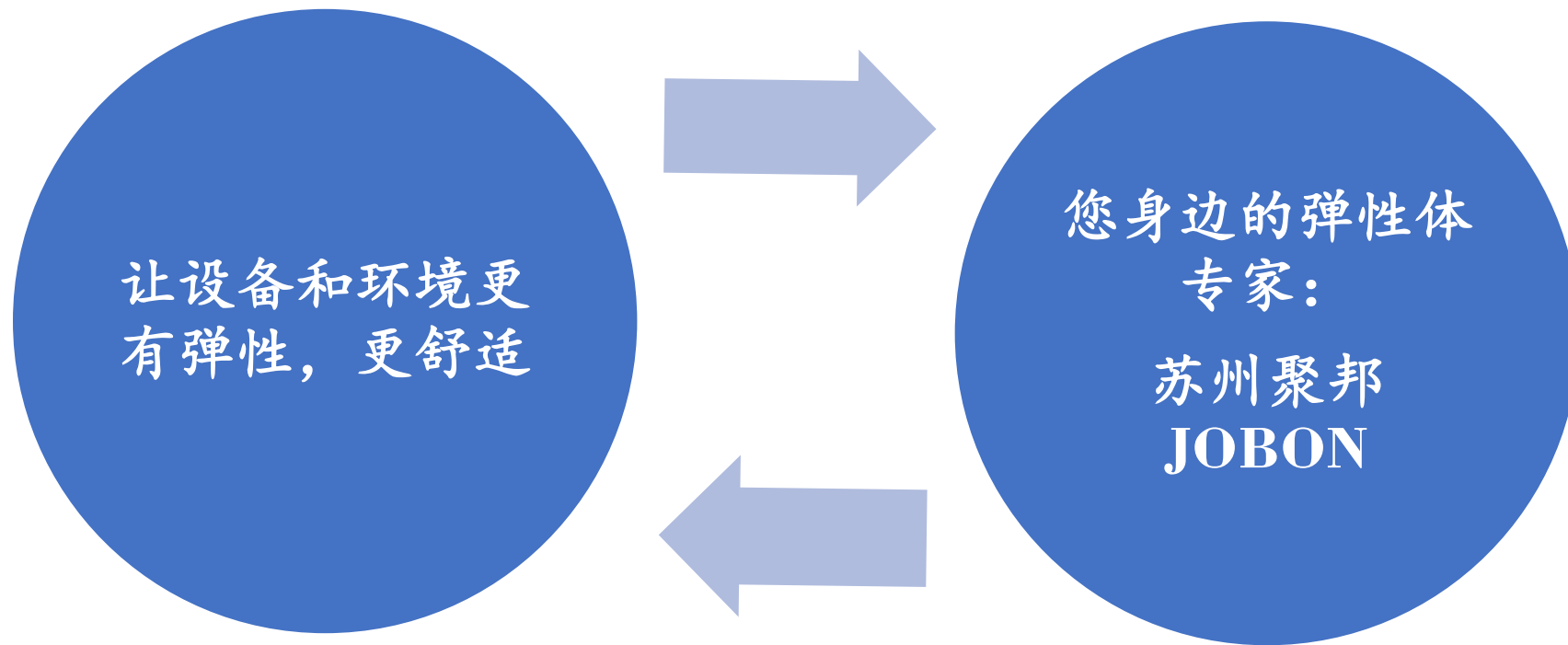

The image shows a close-up, high-angle view of a futuristic keyboard. The keys are dark with glowing blue accents. The 'Joboon' logo is prominently displayed on a key, rendered in a bright, glowing blue font. Below the logo, two lines of Chinese text are also visible, glowing in a lighter blue or white. The overall aesthetic is sleek and high-tech.

Joboon

让世界更有弹性

您身边的弹性体专家

**ANY
QUESTION?**

Thanks!

Contact

Suzhou Jobon Mechanical Technology Co., Ltd
苏州聚邦机械科技有限公司

KK ZHU-朱金刚

**628 Room,2 Block, Jinshan Square, No 6 Weihua Rd, SIP,
Suzhou, Jiangsu, China**

+86 512 6766 5373

+86 158 5169 0906

kkzhu@jobontec.com

kkzhub@163.com